

Entente High Back

Hardwood and plywood internal frame structure

Polished aluminum legs as standard

CMHR foam seat, back and lumbar

Webbed Seat

Top stitch detail

Two tone fabric choices are available for specification

High Back - Individual units

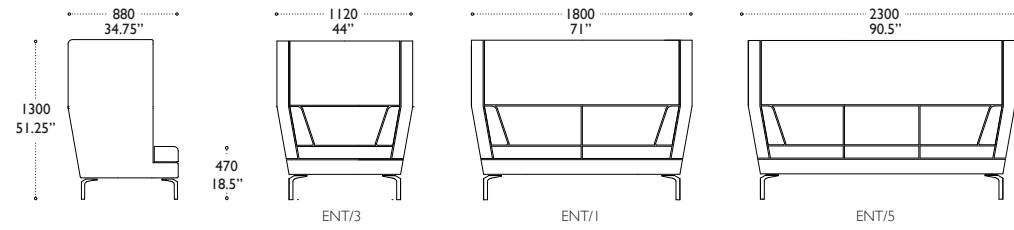

Entente Low Back

Hardwood and plywood internal frame structure

Polished aluminum legs as standard

CMHR foam seat, back and lumbar

Webbed Seat

Top stitch detail

Two tone fabric choices are available for specification

Low Back - Individual units

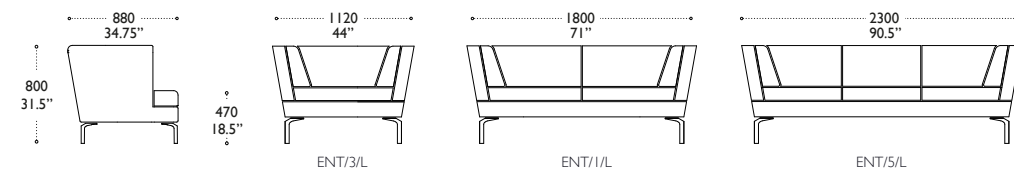

Power & Data Locations

Various power and data options are available to specify on Entente however we have listed our most popular configurations in the options tables.

Drawings are provided for your reference prior to ordering and can be used as a guide

For customers own power please contact us for compatibility

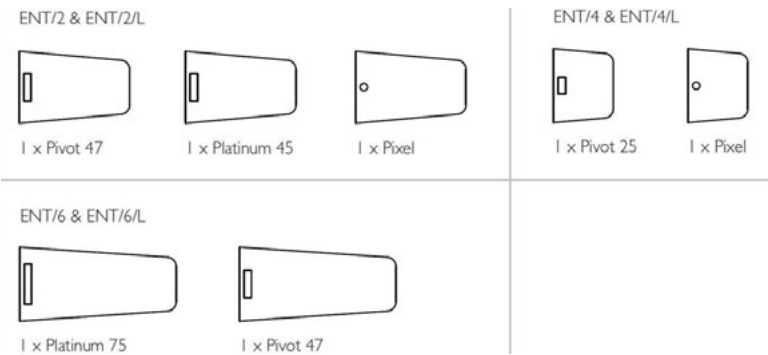

Media Unit: Partition Cable Management

Entente booth units feature concealed cable management in the rear of the partition unit, with 4 positions available for exit grommets to be placed.

Please ensure you state which location you require at the point of order.

Maximum monitor size 28"

Entente Partition - Cable Management

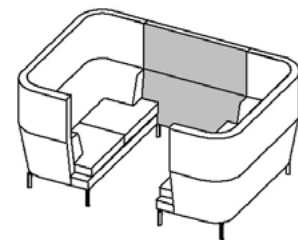

- A - Cable exit grommet below table
- B - Cable exit grommet above table - Low
- C - Cable exit grommet above table - Medium
- D - Cable exit grommet above table - High

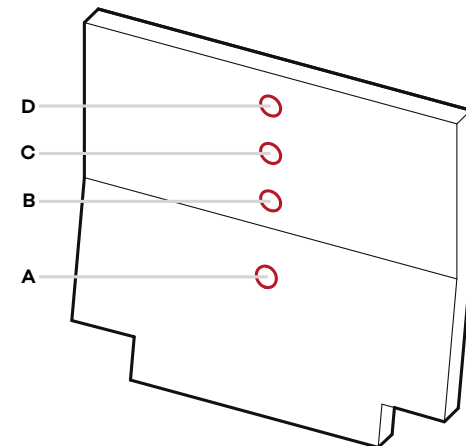

Specification

Entente Specification

Entente is available as standalone sofa unit or as a media booth with table. **N.B.** if specifying a media booth, a monitor and monitor arm is NOT included

Fabrics

Entente can be specified in a multitude of fabrics however we find that Grade 1 fabrics generally aren't suitable for large pieces such as Entente. If there is a Grade 1 fabric you wish to use, please contact a member of our customer services team to discuss suitability.

High or Low back

Entente is available in either high back or Low back configurations:

High Back - 51" (1300mm) High

Low Back - 31.5" (800mm) High

Leg Options

Entente is available as standard with Polished aluminum legs, however it can also be specified with Oak or American Black Walnut legs for an additional up-charge.

Media Booth: Tables

The media unit tables are 28" (715mm) high and attach to the connecting partition wall (which features discreet/concealed cable management)

Media Booth: Table Finishes

Entente Media Booth tables feature a 1" (25mm) top with a chamfered edge and are available in the following finishes:

Veneer - Oak or American Black Walnut

Laminate - Standard Boss or Wilsonart Colors

Table Leg finish:

Polished as standard

Oak or American Black Walnut for an additional upcharge.

Media Booth: Table Power Options

Power and data units are placed on the center line of the table and are positioned near the connecting partition as standard. Power options are dependant on table size so please consult the drawing (left) for more information. If a power option is not listed, or you wish to use an alternative, then please contact your sales representative.

A 72" starter cable is supplied as standard however other lengths are available - see power & data for more information.

Entente Digital Assets

We hold a library of assets for our Entente product range which you can find by scanning the the QR code below. If you are viewing our interactive PDF, simply click on the QR code to be taken directly there.

High Back - Booth units

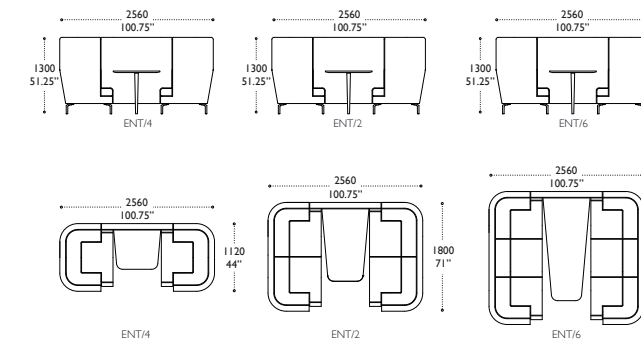

Low Back - Booth Units

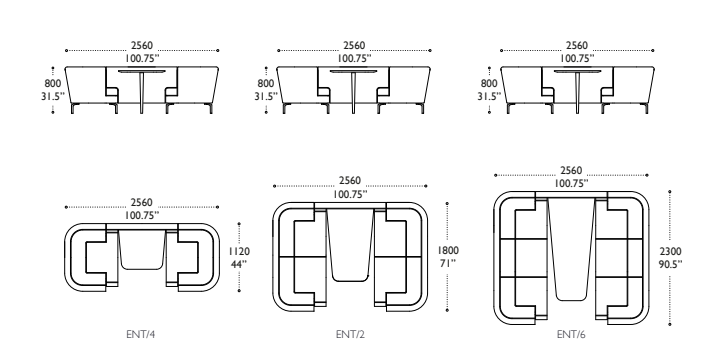

High Back - Suggested Settings

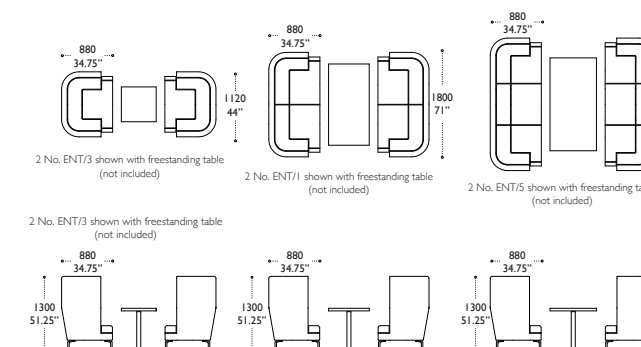

Low Back - Suggested Settings

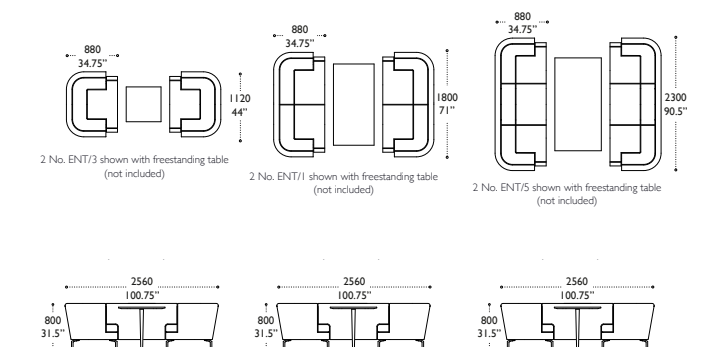

Entente – High Back

Booths

boss

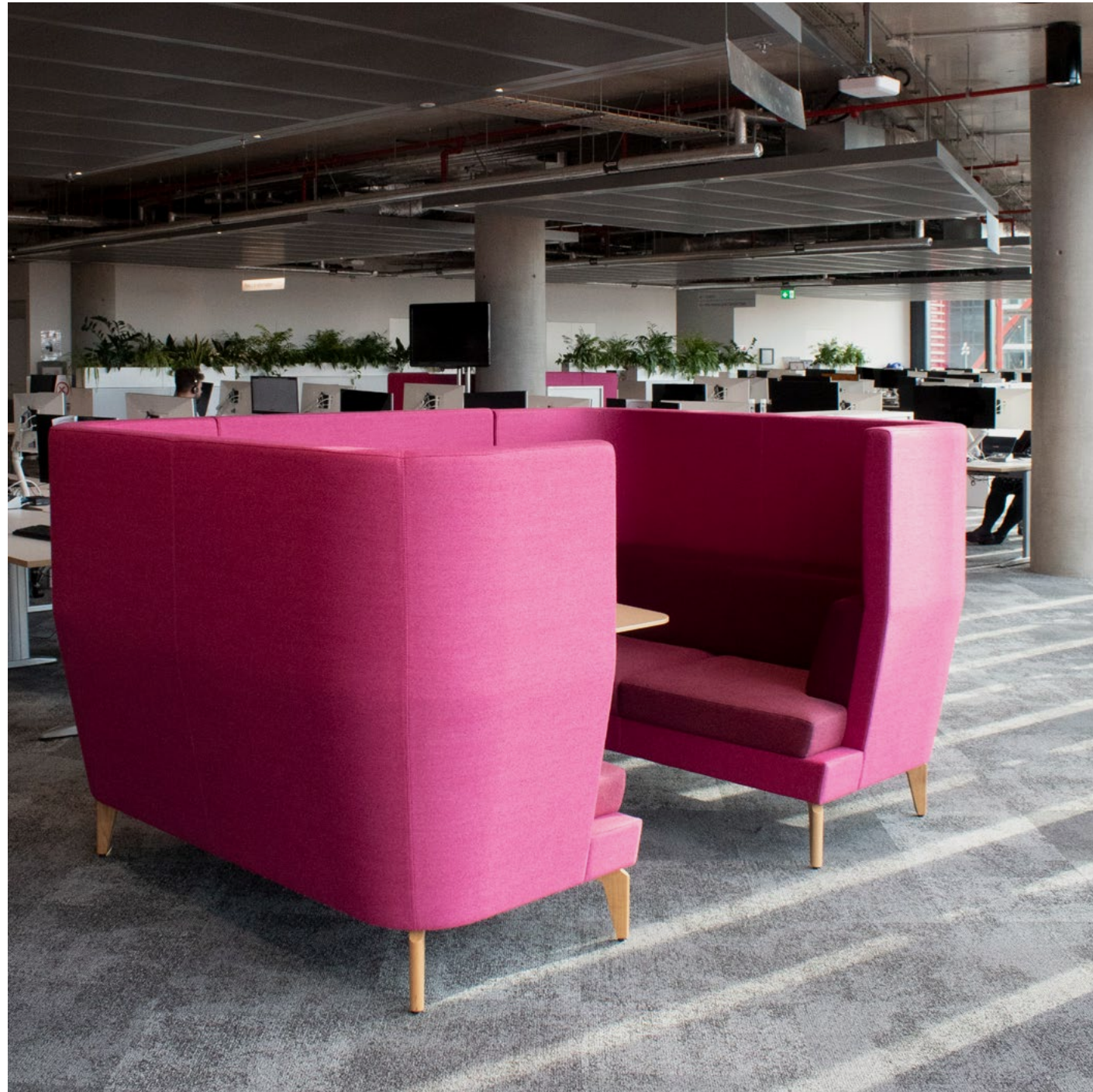



Range Information

- Hardwood & plywood internal frame
- CMHR foam seat, back and lumbar
- Webbed seat
- Top stitch detail
- Booth table top available in an Oak, ABW veneer or Wilsonart laminate - please specify on Purchase Order
- Connecting partition with provision for concealed cable management
- Power and data available - See power & data page
- Polished aluminum legs as standard. Please refer to price options for alternative timber leg options and state selection on Purchase Order.
- Maximum monitor size = 28"
- Monitor Not Included
- Not recommended to be upholstered in Grade 1 fabrics

• **Due to the design of Entente we recommend prior fabric approval to ensure the highest quality finish.**

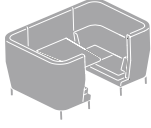

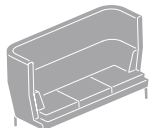
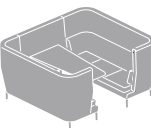
ENTENTE HIGH BACK ENT/...	Code:	Description	COM / 1 2 3 4 5 6 7 8 9 10										(ly)	(lb)
			1	2	3	4	5	6	7	8	9	10		
	ENT/1	Entente 2 seat High-back sofa	4202	4440	4712	4896	5220	5448	5860	6324	6920	7472	6.75	-
		Lumbar	1250	1312	1382	1430	1514	1574	1680	1800	1954	2096	2.25	-
		Seat cushions	1118	1180	1250	1298	1382	1442	1548	1668	1822	1964	2.75	-
		Total \$	6570	6932	7344	7624	8116	8464	9088	9792	10696	11532	11.75	168
	ENT/2	Entente 2 seat booth High-back sofa body	8404	8880	9424	9792	10440	10896	11720	12648	13840	14944	13.50	-
		Lumbar	2500	2624	2764	2860	3028	3148	3360	3600	3908	4192	4.50	-
		Seat cushions	2236	2360	2500	2596	2764	2884	3096	3336	3644	3928	5.50	-
		Partition, table and allowances for P&D (if required)	5316	5412	5522	5596	5726	5818	5984	6170	6408	6630	4.50	-
		Total \$	18456	19276	20210	20844	21958	22746	24160	25754	27800	29694	28.00	417
	ENT/3	Entente 1 seat High-back chair	3196	3346	3518	3634	3838	3982	4242	4534	4908	5256	5.50	-
		Lumbar	950	1012	1082	1130	1214	1274	1380	1500	1654	1796	1.75	-
		Seat cushion	850	912	982	1030	1114	1174	1280	1400	1554	1696	1.75	-
		Total \$	4996	5270	5582	5794	6166	6430	6902	7434	8116	8748	9.00	85
	ENT/4	Entente 1 seat booth High-back chair body	6390	6688	7030	7262	7670	7956	8474	9058	9806	10500	11.00	-
		Lumbar	1898	2020	2160	2256	2424	2542	2754	2994	3300	3584	3.50	-
		Seat cushions	1698	1820	1960	2056	2224	2342	2554	2794	3100	3384	3.50	-
		Partition, table and allowances for P&D (if required)	4190	4286	4396	4470	4600	4692	4858	5044	5282	5504	3.00	-
		Total \$	14176	14814	15546	16044	16918	17532	18640	19890	21488	22972	21.00	219
	ENT/5	Entente 3 seat High-back sofa	5418	5688	5998	6208	6578	6838	7308	7838	8518	9148	9.00	-
		Lumbar	1610	1672	1742	1790	1874	1934	2040	2160	2314	2456	2.25	-
		Seat cushions	1442	1538	1648	1722	1852	1944	2110	2296	2534	2756	3.50	-
		Total \$	8470	8898	9388	9720	10304	10716	11458	12294	13366	14360	14.75	252
	ENT/6	Entente 3 seat booth High-back sofa body	10834	11368	11982	12398	13130	13644	14574	15622	16966	18212	18.00	-
		Lumbar	3218	3340	3480	3576	3744	3862	4074	4314	4620	4904	4.50	-
		Seat cushions	2878	3062	3272	3414	3664	3840	4158	4516	4976	5402	6.75	-
		Partition, table and allowances for P&D (if required)	6296	6392	6502	6576	6706	6798	6964	7150	7388	7610	3.50	-
		Total \$	23226	24162	25236	25964	27244	28144	29770	31602	33950	36128	32.75	554

 Fabric Linear Yard  Leather Square Footage  Product Weight

Options

CODE:	DESCRIPTION	\$	CODE:	DESCRIPTION	\$
CUTOUT	Cut out for customers own power & data	92	-	American Black Walnut Legs Booth including table	1,204
-	Oak Legs - Sofa and Chair	332	P&D	Power & Data options	Page 512
-	Oak Legs Booth including table	710	PAINTED	Painted Metal Legs - Any Standard RAL	\$76 per leg
-	American Black Walnut Legs - Sofa & Chair	526			

Entente – Low Back

Booths

boss





Range Information

- Hardwood & plywood internal frame
- CMHR foam seat, back and lumbar
- Webbed seat
- Top stitch detail
- Booth table top available in Oak, ABW or White finish – please specify on Purchase Order.
- Connecting partition with provision for concealed cable management
- Power and data available - See page 512
- Polished aluminum legs as standard. Please refer to price options for alternative timber leg options and state selection on Purchase Order
- Monitor not available for Low version
- Not recommended to be upholstered in Grade 1 fabrics

• **Due to the design of Entente we recommend prior fabric approval to ensure the highest quality finish.**

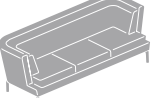
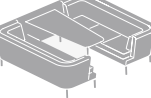

ENTENTE LOW BACK ENT/.../L	Code:	Description	COM/1	2	3	4	5	6	7	8	9	10	(ly)	(lb)
	ENT/1/L	Entente 2 seat Low-back sofa	3942	4132	4350	4498	4758	4940	5270	5642	6118	6560	4.50	-
		Lumbar	1172	1234	1304	1352	1436	1496	1602	1722	1876	2018	2.25	-
		Seat cushions	1048	1110	1180	1228	1312	1372	1478	1598	1752	1894	2.75	-
		Total \$	6162	6476	6834	7078	7506	7808	8350	8962	9746	10472	9.50	135
	ENT/2/L	Entente 2 seat booth Low-back sofa body	7884	8264	8700	8996	9516	9880	10540	11284	12236	13120	9.00	-
		Lumbar	2344	2468	2608	2704	2872	2992	3204	3444	3752	4036	4.50	-
		Seat cushions	2096	2220	2360	2456	2624	2744	2956	3196	3504	3788	5.50	-
		Partition, table and allowances for P&D (if required)	4718	4786	4864	4918	5012	5078	5196	5330	5500	5658	2.25	-
		Total \$	17042	17738	18532	19074	20024	20694	21896	23254	24992	26602	21.25	333
	ENT/3/L	Entente 1 seat Low-back chair	2874	2982	3106	3190	3338	3442	3630	3842	4114	4366	3.50	-
		Lumbar	854	916	986	1034	1118	1178	1284	1404	1558	1700	1.75	-
		Seat cushion	764	826	896	944	1028	1088	1194	1314	1468	1610	1.75	-
		Total \$	4492	4724	4988	5168	5484	5708	6108	6560	7140	7676	7.00	66.25
	ENT/4/L	Entente 1 seat booth Low-back chair body	5748	5964	6212	6380	6676	6884	7260	7684	8228	8732	6.75	-
		Lumbar	1708	1832	1972	2068	2236	2356	2568	2808	3116	3400	3.50	-
		Seat cushions	1528	1652	1792	1888	2056	2176	2388	2628	2936	3220	3.50	-
		Partition, table and allowances for P&D (if required)	4072	4140	4218	4272	4366	4432	4550	4684	4854	5012	2.25	-
		Total \$	13056	13588	14194	14608	15334	15848	16766	17804	19134	20364	16.00	175
	ENT/5	Entente 3 seat Low-back sofa	5092	5308	5556	5724	6020	6228	6604	7028	7572	8076	8.00	-
		Lumbar	1512	1574	1644	1692	1776	1836	1942	2062	2216	2358	2.25	-
		Seat cushions	1354	1450	1560	1634	1764	1856	2022	2208	2446	2668	3.50	-
		Total \$	7958	8332	8760	9050	9560	9920	10568	11298	12234	13102	13.75	201
	ENT/6/L	Entente 3 seat booth Low-back sofa body	10178	10610	11106	11442	12034	12450	13202	14050	15138	16146	16.00	-
		Lumbar	3022	3144	3284	3380	3548	3666	3878	4118	4424	4708	4.50	-
		Seat cushions	2706	2890	3100	3242	3492	3668	3986	4344	4804	5230	6.75	-
		Partition, table and allowances for P&D (if required)	4962	5030	5108	5162	5256	5322	5440	5574	5744	5902	2.25	-
		Total \$	20868	21674	22598	23226	24330	25106	26506	28086	30110	31986	29.50	243

 Fabric Linear Yard  Leather Square Footage  Product Weight

Options

CODE:	DESCRIPTION	\$	CODE:	DESCRIPTION	\$
CUTOUT	Cut out for customers own power & data	92	-	American Black Walnut Legs Booth including table	1,204
-	Oak Legs - Sofa and Chair	332	P&D	Power & Data options	Page 512
-	Oak Legs Booth including table	710	PAINTED	Painted Metal Legs - Any Standard RAL	\$76 per leg
-	American Black Walnut Legs - Sofa & Chair	526			

BOOTH